

Article number: 12348000100500  
Description: KLEE-coil 348 000 100.500  
M 10 St. steel 1.4305

## Measures

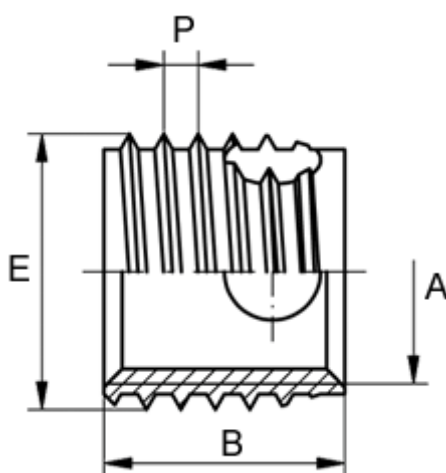

Female thread A	= M10
Length B	= 18
Male thread E	= 12.0
Min hole depth blind hole	= 22
Pre-drilled max	= 11.5
Pre-drilled min	= 11.2
Thread pitch P	= 1.50
Type	= 348 000 100 ...